

OPzS

BATTERIES
TECHNICAL
DATA



TAB OPzS

TECHNICAL DATA AND DIMENSIONS

6V 4 OPzS 200

↑ Rated voltage
↑ Number of positive plate
↑ Type of plates
↑ Capacity at 10-hour discharging

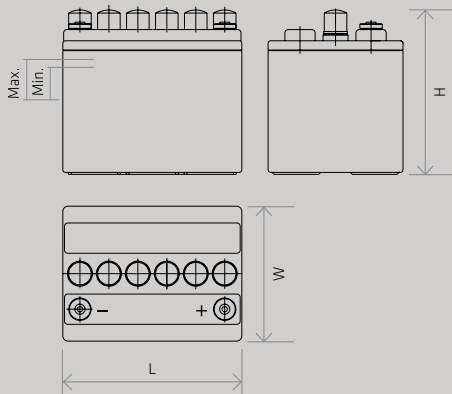

TERMINAL POST BOLTED VERSION

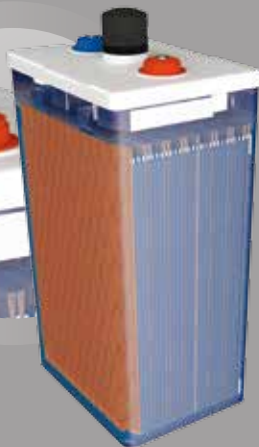

TERMINAL POST WELDED VERSION

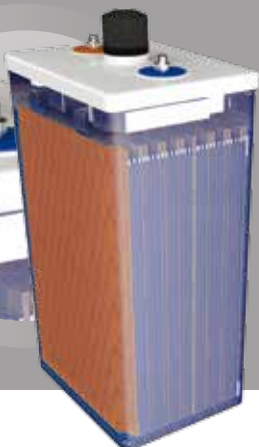

LOW MAINTENANCE TAB OPzS VENTED STATIONARY BATTERIES



LET US LEAD YOU INTO THE WORLD OF EVERLASTING ENERGY AND INTRODUCE YOU WITH OPzS STATIONARY BLOCKS AND CELLS PRODUCED IN THE CONVENTIONAL LEAD-ACID TECHNOLOGY.

The batteries are distinguished for:

- » HIGH CAPACITY
- » LONG LIFE TIME
- » REDUCED MAINTENANCE
- » LOW SELF-DISCHARGING
- » QUICK AND SIMPLE ACID LEVEL CONTROL
- » ECONOMICAL WATER CONSUMPTION
- » APPROPRIATE DIMENSIONS AND WEIGHT
- » THE LOWEST AND CONSTANT MAINTENANCE CURRENT.

The individual cells (2V) and blocks (6V and 12V) are in translucent plastic containers made of styrenacrylnitril (SAN), a material which is extraordinary resistant to chemical influences and mechanical damage.

The stationary batteries of the type OPzS are manufactured according to the DIN 40736, EN 60896 and IEC 896-1 regulations.

APPLICATION

Stationary batteries of the OPzS type are intended for the supply of telecommunication facilities, computers, emergency lightning, alarm, control and monitoring systems in power plants and distribution stations, at railway stations, airports etc.

Due to their extremely low self-discharging they are suitable for plants supplied by solar cells.

OPERATION MAINTENANCE

IT IS RECOMMENDED THAT THE OPzS BATTERIES ARE INSTALLED IN THE SYSTEMS WHERE THEY ARE CONSTANTLY CONNECTED TO THE RECTIFIER.

The battery can be float-charged with voltage of 2.23 to 2.25 V/cell, or, in case of rapid charging after discharge, with voltage of 2.35 to 2.40 V/cell.

Rapid charging usually lasts another 3-5 hours after the voltage has already reached 2.35 to 2.40 V/cell. After that, an automatic switchover to the constant maintaining voltage of 2.23 to 2.25 V/cell takes place. Battery maintenance is reduced to a minimum and required only from time to time.

AT NORMAL OPERATION, ONLY SOME DISTILLED WATER HAS TO BE ADDED ONCE IN A 2-3 YEAR PERIOD AND, IF NECESSARY, THE SURFACE OF CELLS HAS TO BE CLEANED. ALL STATED VOLTAGE VALUES ARE VALID FOR THE TEMPERATURE RANGE FROM 15 TO 25 DEGREES C. OUT OF THIS RANGE, THE CORRECTIONS GIVEN BY THE BATTERY PRODUCER ARE NECESSARY.

FOR DETAIL INFORMATION PLEASE CHECK OUR OPERATION MANUAL.

ORDERS

IN ORDER THAT THE BATTERIES WOULD MEET ALL YOUR DEMANDS, WE KINDLY ASK YOU TO ENCLOSE THE FOLLOWING DATA WITH YOUR ORDER:

- » kind of **consuming device** (telephone plant, DC-AC converter, emergency lightning etc.)
- » **operating energy** of the consumer (kW, kVA, $\cos \Phi$)
- » minimum and maximum **allowable rated voltage** at consuming device (V)
- » **time diagram** of a consumer load, and the required time autonomy (reserve)
- » **expected voltage drop** in the supply lines
- » **surrounding temperature** in the battery room (average, minimum, maximum)
- » **type of rectifier**, its characteristics, regulating point I (A) or U (V), respectively, float voltage (V) (direct voltage of rapid-charging current I_{max} (A), float charging voltage)
- » **outline** or dimensions of a battery room
- » **type of installation** (welded, bolted, on wooden or metal racks, in case, on earthquake-proof racks)
- » **battery maintenance accessories** (areometers, thermometers, jug ...)
- » **battery type**: filled up with electrolyte and electrically charged or dry-charge battery.

IN CASE OF PROBLEMS WITH ORDERING WE WILL BE GLAD TO ADVISE AND ASSIST YOU IN THE SELECTION OF THE SUITABLE TYPE OF BATTERY.



CONSTRUCTION

The positive armored plate is of a tubular type, which means that the active substance (PbO_2) is contained in special gauntlet made of polyester fibres and hardened by an impregnation compound. Such construction prevents escaping of an active substance during the operation and ensures a long life time.

The grids of a positive and a negative plate are made of special low percentage (less than 2 %) antimony alloy with addition agents for improvement of crystalline structure of casting.

Negative plates are pasted-type plates with special alloys maintaining porosity of an active substance during the operation. As an electrolyte, a diluted sulphuric acid (H_2SO_4) with a density of 1.24 ± 0.01 kg/l at 20 degrees C, and at a maximum permitted level is used. Separators separating the positive plates from the negative ones are made of microporous plastic material with a low electric resistance.

The cell containers are made of transparent SAN, while lid of nontransparent SAN or ABS material (SAN for blocks, ABs for 2V cells). In a special process, the lids are tightly sealed to the container. The terminal plugs are sealed with rubber seals. This prevents any escape of electrolyte from the cells.

Due to the transparent containers the electrolyte level is clearly visible, the maximum and minimum levels are marked on a self-adhesive acid-proof label on a container side.



A cell plug seals well (ceramic filter), and prevents leakage of any sulphuric acid vapours, however, it lets through hydrogen and oxygen.

Two versions of batteries are being manufactured:

» DRY-CHARGE VERSION:

a battery has to be filled up with an electrolyte and supplementary charged before use.

The plates are already formed and in a special process protected against oxidation.

They can be stored without problems.

» ELECTROLYTE-CHARGE:

battery can be installed immediately, because it is already filled up with electrolyte and electrically charged as well. The capacity test has already been performed by the producer.

IMPROVED DESIGN FOR BOLTED VERSION TERMINAL POST

NEW TYPE OF POLE FOR STATIONARY APPLICATIONS HAS A SPECIAL DESIGN WITH EMBRACED INJECTED PLASTIC AROUND PRE-MACHINED LEAD PART IN THE SEALING AREA.

PLANE AND CLEAN SURFACE OF PLASTIC PART IN COMBINATION WITH RUBBER SEALING RING ENSURES PERFECT SEAL. LONG POLE GROWTH AND MOVING UPWARDS BY THE GROWTH OF POSITIVE PLATE. SUCH CONSTRUCTION ENSURES TIGHT POLE BUSHING WITHOUT ANY CORROSION OR DETERIORATION DURING BATTERY LIFE.

TAB OPzS (BLOCKS)* AND CELLS



TAB OPzS STATIONARY BLOCKS (CELLS) ARE PRODUCED IN THE CONVENTIONAL LEAD-ACID TECHNOLOGY.

Stationary batteries of the OPzS type are intended for the supply of telecommunication facilities, computers, emergency lightning, alarm, control and monitoring systems in power plants and distribution stations, at railway stations, airports etc.

DESIGN

OPzS cells (*block*)*

POSITIVE ELECTRODE

» Tubular plate with low antimony alloy (<2 %)

NEGATIVE ELECTRODE

» Flat with long life expander active material

SEPARATION

» Microporous separator

ELECTROLYTE

» Sulphuric acid of 1,24 kg/l at 20 °C

CONTAINER

» High impact, transparent SAN LID

» ABS (SAN)* in grey color

BLOCKS WITH BLIND CELLS

» 4V, 6V, 8V, 10V

PLUGS

» Ceramic plugs according to DIN 40740

POLE SEALING

» 100 % gas- and electrolyte-tight, sliding-pole

CONNECTOR

» Flexible insulated copper cable with cross-section of 35, 50, 70, 95 or 120 mm² (35, 50 or 70 mm²)*

KIND OF PROTECTION

» IP 25 regarding DIN 40050, touch protected according VBG 4



Uf V/cell	1,80	1,77	1,75	1,67	IEC 896-1		Dimensions [mm]			Weight [kg]		
					RI [mΩ]	Isc [A]	L	W	H	Dry	Wet	
Discharging [h]	10	5	3	1								
CELL TYPE												
12V 1 OPzS 50	51	40,9	38,0	28,4	20,0	613	272	205	392	26	39	
12V 2 OPzS 100	103	81,8	75,7	56,7	9,3	1290	272	205	392	38	50	
12V 3 OPzS 150	154	122,6	113,7	85,1	6,9	1739	380	205	392	53	69	
6V 4 OPzS 200	204	167,0	149,3	115,2	2,2	2703	272	205	392	36	47	
6V 5 OPzS 250	255	208,6	186,6	143,6	1,9	3175	380	205	392	44	61	
6V 6 OPzS 300	307	250,5	223,7	172,0	1,6	3846	380	205	392	52	68	

12V 2 OPzS 100

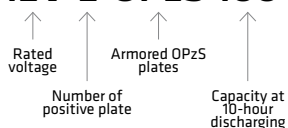

Electrolyte density:
1,24 ± 0,01kg/l at 20 °C.

All measures and weights are within standard production tolerances.
Electrical values are approximative.
Technical modifications are reserved without prior notice.



CHARGING

OPzS cells (block)*

IU - CHARACTERISTIC

» I_{max} without limitation

FLOAT CHARGE

» U = 2,23 V/cell ± 1 %,
between 10 °C and 30 °C
 $\Delta U/\Delta T = -0,004 \text{ V/K}$

» below 10 °C or above 30 °C
in the monthly average

BOOST CHARGE

» U = 2,35 to 2,40 V/cell, time limited

CHARGING TIME UP TO 92 %

» 6h with 1,5*10 initial current,
2,23 V/cell, 50 % C10 discharged

DISCHARGE CHARACTERISTICS

OPzS cells (block)*

REFERENCE TEMPERATURE

» 20 °C

INITIAL CAPACITY

» 100 %

DEPTH OF DISCHARGE

» Normally up to 80 %

» More than 80 % DOD or discharges
beyond final discharge voltages
(dependent on discharge current)
have to be avoided

MAINTENANCE

OPzS cells (block)*

EVERY 6 MONTH

» Check battery voltage,
pilot block voltage, temperature

EVERY 12 MONTH

» Take down battery voltage,
block voltage, temperature

OPERATIONAL DATA

OPzS cells (block)*

DESIGN LIFE

» Up to 20 years
(18 years)* at 20 °C

WATER REFILLING INTERVAL

» More than 2 years
at 20 °C

IEC 896-1 CYCLES

» 1500 (1200)*

SELF-DISCHARGE

» Approx. 2 % per
month at 20 °C

OPERATIONAL TEMPERATURE

» -20 °C to 55 °C,
recommended 10 °C
to 30 °C

VENTILATION REQUIREMENT

» according to EN 50272-2

MEASUREMENTS ACCORDING

» DIN 40 737 part 1

TESTS ACCORDING

» IEC 896-1

SAFETY STANDARDS

» VDE 0510 part 2 and
EN 50272-2

TRANSPORT

» No dangerous goods
during road transport

Uf V/cell	1,80	1,77	1,75	1,67	IEC 896-1		Dimensions [mm]			Weight [kg]		Nº of Poles
	Discharging [h]	10	5	3	1	Ri [mΩ]	Isc [A]	L	W	H	Dry	
CELL TYPE												
2 OPzS 100	107	94	82	60	1,48	1350	103	206	420	8,7	13,7	2
3 OPzS 150	155	136	117	86	1,08	1845	103	206	420	11	16	2
4 OPzS 200	208	180	158	115	0,84	2376	103	206	420	13	18	2
5 OPzS 250	259	224	197	144	0,69	3887	124	206	420	16	22	2
6 OPzS 300	310	268	234	171	0,58	3438	145	206	420	18	26	2
5 OPzS 350	380	325	280	205	0,64	3137	124	206	536	20	29	2
6 OPzS 420	454	389	336	245	0,55	3641	145	206	536	24	34	2
7 OPzS 490	532	454	392	286	0,48	4169	166	206	536	28	39	2
6 OPzS 600	640	544	477	348	0,45	4466	145	206	711	35	50	2
8 OPzS 800	853	727	638	466	0,33	6035	210	191	711	46	65	4
10 OPzS 1000	1065	909	796	581	0,26	7720	210	233	711	57	80	4
12 OPzS 1200	1278	1088	954	696	0,23	8814	210	275	711	66	93	4
12 OPzS 1500	1613	1381	1196	873	0,23	8605	210	275	861	88	119	4
16 OPzS 2000	2143	1838	1591	1162	0,17	12042	212	397	837	115	160	6
20 OPzS 2500	2675	2295	1988	1452	0,13	15007	212	487	837	145	200	8
24 OPzS 3000	3208	2752	2382	1739	0,12	17390	212	576	837	170	240	8

3 OPzS 150

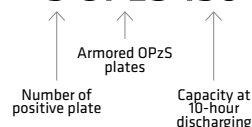

CABLE CONNECTORS for OPzS blocks

BLOCKS	CROSS-SECTION	DISTANCE	CABLE CONNECTOR'S LENGTH (B/W = between)				CODE NUMBERS FOR CABLE CONNECTORS			
	[mm ²]	B/W blocks [mm]	B/W blocks [mm]	B/W rows [mm]	B/W rows [mm]	B/W tiers [mm]	B/W blocks	B/W rows	B/W rows	B/W tiers
12V 1 OPzS 50	35	15	85	190	450	1250	627946	628306	551552	8352498
12V 2 OPzS 100	35	15	85	190	450	1250	627946	628306	551552	8352498
12V 3 OPzS 150	35	15	95	190	450	1250	627947	628306	551552	8352498
6V 4 OPzS 200	50	15	165	300	600	1250	627850	6130526	628418	8352497
6V 5 OPzS 250	50	15	190	300	600	1250	627851	6130526	628418	8352497
6V 6 OPzS 300	70	15	190	300	600	1250	628311	6127470	628317	6131862

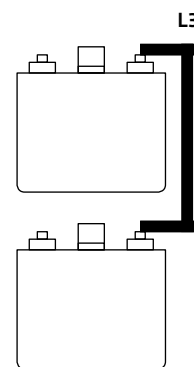
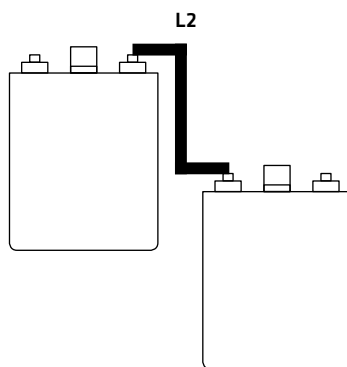
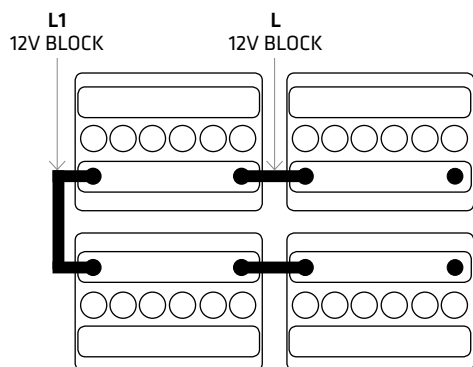

CABLE CONNECTORS for OPzS cells

CELLS	CROSS- DISTANCE		CABLE CONNECTOR'S LENGTH (B/W = between)					CODE NUMBERS FOR CABLE CONNECTORS			
	SECTION	B/W cells	B/W cells	B/W rows	B/W rows	B/W tiers	B/W cells	B/W rows	B/W rows	B/W tiers	
	[mm ²]	[mm]	L [mm]	L1 [mm]	L2 [mm]	L3 [mm]	L L1	L2	L3		
2 OPzS 100	1	35	7	110	165	500	1250	627949	628303	628305	8352498
3 OPzS 150	1	35	7	110	165	500	1250	627949	628303	628305	8352498
4 OPzS 200	1	50	7	110	165	500	1250	627944	627850	628300	8352497
5 OPzS 250	1	50	8	145	165	500	1250	627953	627850	628300	8352497
6 OPzS 300	1	70	8	165	165	500	1250	402379	402379	628817	6131862
5 OPzS 350	1	70	8	150	165	500	1250	628310	402379	628817	6131862
6 OPzS 420	1	95	8	165	165	500	1250	927947	927947	628103	6131863
7 OPzS 490	1	95	8	190	165	500	1250	630666	927947	628103	6131863
6 OPzS 600	1	120	8	163	163	500	1250	630705	630705	627670	6131864
8 OPzS 800	2	95	13	120	300	600	1250	8353435	6131866	628419	6131863
10 OPzS 1000	2	95	13	120	350	600	1250	8353435	638768	628419	6131863
12 OPzS 1200	2	120	13	118	350	600	1500	8353434	627669	625670	321321
12 OPzS 1500	2	120	13	118	350	600	1500	8353434	627669	625670	321321
16 OPzS 2000	3	120	13	130	500	750	1500	630700	627670	629901	321321
20 OPzS 2500	4	120	13	130	600	1000	1500	630700	625670	630704	321321
24 OPzS 3000	4	120	13	130	700	1000	1500	630700	627671	630704	321321

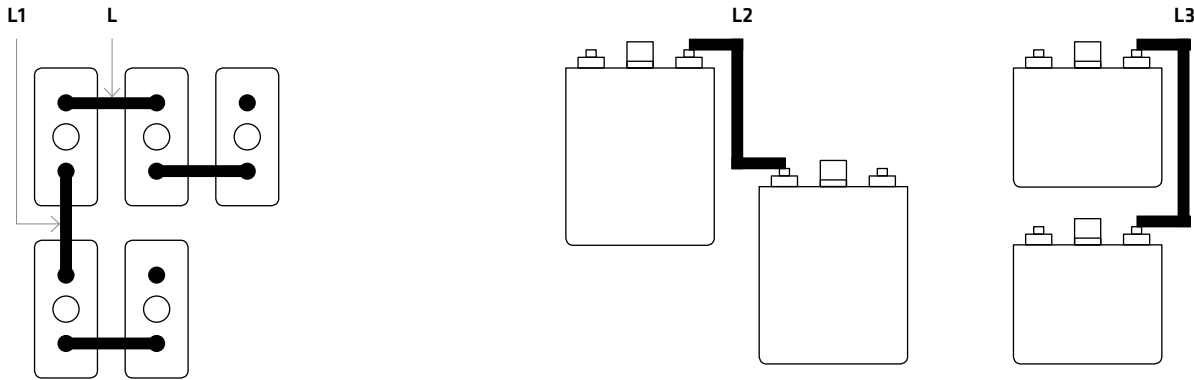

Rigid connectors for OPzS cells

CELLS	CROSS-SECTION [a×b]	CROSS-SECTION [mm ²]	Distance between cells L [mm]	Between cells L1 [mm]	Rigid Code N°	TAB code N°
2 OPzS 100	3 × 30	90	12	115	56030115	8362137
3 OPzS 150	3 × 30	90	12	115	56030115	8362137
4 OPzS 200	3 × 30	90	12	115	56030115	8362137
5 OPzS 250	3 × 30	90	11	135	56030135	8361497
6 OPzS 300	3 × 30	90	10	155	56030155	8364053
5 OPzS 350	3 × 30	90	11	135	56030135	8361497
6 OPzS 420	3 × 30	90	10	155	56030155	8364053
7 OPzS 490	3 × 30	90	9	175	56030175	8364055
6 OPzS 600	5 × 30	150	10	155	56050155	8364053
8 OPzS 800	3 × 30	90	13	115	56030175	8364055
10 OPzS 1000	5 × 30	150	13	115	56050115	8362899
12 OPzS 1200	5 × 30	150	13	115	56050115	8362899
12 OPzS 1500	5 × 30	150	13	115	56050115	8362899
16 OPzS 2000	5 × 30	150	11	115	56050115	8362899
20 OPzS 2500	5 × 30	150	11	115	56050115	8362899
24 OPzS 3000	5 × 30	150	11	115	56050115	8362899

OPERATING INSTRUCTIONS

FOR STATIONARY VENTED LEAD-ACID OPzS BATTERIES

(also for OGi, UPS and TOPzS batteries)

NOMINAL DATA

Nominal voltage:	$U_n = 2.0 \text{ V} \times \text{number of cells}$
Nominal capacity (see plate type):	$C_n = C10$ (10-hour discharge)
Nominal discharge current:	$I_n = I10 = C_n/10$
Final discharge voltage:	$U_s = 1.80 \text{ V/cell}$
Nominal S.G. of electrolyte:	$1.24 \pm 0.01 \text{ kg/l}$
Nominal temperature:	$T_n = 20 \text{ }^\circ\text{C}$
"LA" antimony content:	$< 2\% \text{ in the grids}$

1. COMMISSIONING

1.1 Filled and charged batteries. Before commissioning all blocks must be inspected for mechanical damage, cells must be connected with the correct polarity and connectors firmly seated. The following torque apply for M10 screw connectors: **20 Nm \pm 1 Nm**. If necessary the terminal covers must be put on. Check the electrolyte level in all cells. If necessary top up to maximum level with purified water as under DIN 43530 Part 4. Before putting the battery in operation, plastic transport vent caps must be removed and replaced with ceramic cell plugs. With charger off and loads isolated connect battery to the direct current power supplies maintaining correct polarity (positive terminal to positive post). Switch on the charger and charge as under section 2.2.

1.2 Dry charged (DC) batteries. Instructions for the initial charging of a dry charged stationary OPzS, Ca OPzS and SOLAR (TOPzS) batteries:

- + Unscrew the sealed vent plugs and fill the cells with pure dilute sulphuric acid, specific gravity $1.230 \pm 0.01 \text{ kg/l}$ read at $20 \text{ }^\circ\text{C}$ (68 F), up to max level marked on the label. The temperature of the filling acid should be between $10 \text{ }^\circ\text{C}$ and $25 \text{ }^\circ\text{C}$ (50-77 F).
- + Insert the original plastic vent plug with removed sealing foil on the top or place the special ceramic vent plug.
- + Start charging for not less than 2 and not more than 12 hours elapsed after the last cell has been filled with the acid.
- + Apply the $0.5 \times I10$ (5 A/100 Ah) current.
- + Charge for 8 hours and then keep the battery on open circuit for 1-2 hours.
- + Continue the charging for a few hours, until the battery is fully charged, i.e. until constant voltage and constant specific gravity have been reached. The specific gravity of the acid in a fully charged cell is $1.240 \pm 0.01 \text{ kg/l}$ read at $20 \text{ }^\circ\text{C}$ (68 F), if during the charging the temperature of the acid exceeds $55 \text{ }^\circ\text{C}$ (131 F), reduce the charging current by 50 %.
- + 0.5 h after charging discharge the battery at 10 hour rate of current until the cell voltage drops to average value 1.80 Volts. Allowable minimum voltage of a single cell is 1.70 V.
- + Recharge the battery according to the operating instructions 2.2.
- + 24 hours after recharging adjust electrolyte level to the "max" mark on the label. Activation and test results must be kept as part of battery documentation. Non-compliance with this request renders the warranty null and void.

2. OPERATION

For the operation of stationary battery, apply EN 50272-2 installations.

2.1 Discharging. Never allow the final discharge voltage of the battery to drop below that assigned for the discharge current.

Charge immediately after discharge as well as partial discharge. Recommended DOD (Depth Of Discharge) for normal operating is up to 80 % of C_n .

2.2 Charging. All charging procedures with their limit values may be employed as stated:

IU characteristic (DIN 41773), **W characteristic** (DIN 41774) and **I characteristic** (DIN 41776).

Depending on charger type and charging characteristic alternating currents flow through the battery superimposing onto the direct current. These alternating currents and the reaction of the loads lead to an additional warming of the battery and strain on the electrodes with possible resulting damage (see 2.5). Depending on the system at hand, charging may be carried out under the following modes:

2.2.1. Stand-by parallel operation and floating operation. Here the load, direct current and battery are continuously connected in parallel. Thereby the charging voltage is at the same time the operating voltage of the system.

With stand-by-parallel operation the direct current is at any time capable of supplying the maximum load current and the battery charging current. The battery only supplies current when the direct current source fails. The charge voltage should be set at $2.23 \text{ V} \pm 1\% \times \text{number of cells}$ measured at the battery's terminals. To reduce the recharging time a charging stage can be applied in which the charging voltage is 2.35 to $2.4 \text{ V} \times \text{number of cells}$ (stand-by parallel operation with recharging stage). Automatic changeover to the charging voltage of $2.23 \text{ V} \pm 1\% \times \text{number of cells}$ follows after few hours on the voltage 2.35 - $2.4 \text{ V} \times \text{number of cells}$. With the floating operation the direct current source is not able to supply the maximum load current at all times. The load current intermittently supersedes the nominal current of the direct current source. During this period the battery supplies power. It is not fully charged at all times. Therefore, depending on the load the charge voltage must be set at 2.23 to $2.30 \text{ V} \times \text{number of cells}$.

2.2.2. Switch mode operation

When charging, the battery is separated from the load. Towards the end of the charging process the charge voltage of the battery is 2.6 - 2.75 V/cell . The charging process and parameters must be monitored (see Sections 2.4, 2.5 and 2.6). On reaching a fully charged state the charging process must be stopped or switched to float charge as under Section 2.3.

2.2.3. Battery operation (charge / discharge operation).

Only the battery supplies the load. Hereby the charge voltage of the battery towards the end of the charging process is 2.6 - 2.75 V/cell . The charging process and parameters must be monitored (see Sections 2.4, 2.5 and 2.6). When reaching a fully charged state the charging process must be switched off. The battery can be switched to the load as necessary.

2.3 Maintaining the full charge (float charging)

Devices complying with the stipulations under DIN 41773 (IU characteristic) must be used. They are to be set so that the average cell voltage is $2.23 \text{ V} \pm 1\%$ ($2.25 \text{ V} \pm 1\%$ for UPS) cell at $20 \text{ }^\circ\text{C}$ and the electrolyte density does not decrease over a protracted period (otherwise see 2.8)

2.4 Equalizing charge

Equalizing charges are required after exhaustive discharges and after inadequate charges; they can be carried out as follows: Up to 72 hours at constant voltage of max. 2.4 V/cell , with the I or W characteristic as under 2.6.

If during equalizing charging permitted load voltages are exceeded, appropriate measures must be taken, e. g. disconnection of the load. If exceeding the maximum temperature of $55 \text{ }^\circ\text{C}$, the charging must either be stopped, proceed with reduced current, or be switched to float charge to allow the temperature to drop. The equalizing charge is completed when the electrolyte densities no longer increases within a period of 2 hours.

2.5 Alternating currents with periodic deviations. On recharging up to 2.4 V/cell as under operation modes a) to c), the actual value of the alternating current is occasionally permitted to reach max. 20 A per 100 Ah nominal capacity. Above 2.4 V/cells 10 A per 100 Ah nominal capacity may not be exceeded. In a fully charged state with a charge voltage of 2.23 to 2.30 V/cell the actual value of the alternating current must not exceed 5 A per 100 Ah nominal capacity.

2.6 Charging currents. The charging currents are not limited up to 2,4 V/ cell. When exceeding the charging voltage of 2,4 V/cell, greater water decomposition occurs. The charging currents per 100 Ah nominal capacity shown in Table 1 must not be exceeded.

CHARGING PROCEDURE	CELL MODEL	CELL VOLTAGE
I characteristic	5,0 A	2,6–2,75 V
W characteristic	7,0 A 3,5 A	at 2,4 V at 2,65 V

2.7 Temperature. The recommended operating temperature for Lead-acid batteries is 10 °C to 30 °C. The technical data apply for the nominal temperature 20 °C. The ideal operating temperature is 20 ± 5 °C. Higher temperatures shorten the service life. Lower temperatures reduce the available capacity. The maximum temperature of 55 °C must not be exceeded.

2.8 Temperature-related charge voltage. A temperature-related adjustment of the charge voltage within the operating temperature of 15 °C to 25 °C is not necessary. Should the temperature range be lower than 15 °C and/or higher than 25 °C, a temperature related adjustment of the charge voltage should be made. The temperature correction factor is (-0.004 V/Cell per K). Should the temperature constantly rise above 40 °C then the factor is (-0.003 V/Cell per K).

2.9 Electrolyte. The electrolyte is diluted sulphuric acid. The nominal electrolyte density is based on 20 °C and the nominal electrolyte level when fully charged with maximum deviation ± 0.01 kg/l. Higher temperatures reduce the electrolyte density; lower temperatures increase the electrolyte density. The associated correction factor is 0.0007 kg/l per K. Example: electrolyte density of 1.23 kg/l at 35 °C corresponds to a density of 1.24 kg/l at 20 °C or electrolyte density of 1.25 kg/l at 5 °C corresponds to a density of 1.24 kg/l at 20 °C.

3. BATTERY MAINTENANCE AND CONTROL

The electrolyte level must be checked regularly. If it drops to the lowest electrolyte level mark, purified water must be added as under DIN 43530 Part 4, maximum conductivity 30 µS/cm. To avoid leakage currents keep the battery clean and dry (especially inter cell connections). Plastic battery components, in particular the vent caps, must only be cleaned with water that contains no additives.

At least every 6 months the following must be measured and recorded:

- + battery voltage;
- + voltage of a few selected cells / mono block batteries;
- + electrolyte density of a few selected cells/ mono block batteries;
- + electrolyte temperature of a few selected cells/mono block batteries. In case float charge voltage in one cell deviates for more than +0.1 V or -0.05 V from average values (see point 2.3) equalizing charge must be submitted.

The following must be measured and recorded annually:

- + voltage of all cells/mono block batteries;
- + electrolyte density of all cells/mono block batteries;
- + electrolyte temperature of a few selected cells/mono block batteries;
- + should the float charge voltage in one cell deviate more than +0.1 V or -0.05 V from the average value (see 2.3), equalizing charging should be done (see 2.4).

Annual visual checks:

- + on bolted connectors (check that unsecured bolt connectors are firmly seated);
- + on battery installation or arrangement;
- + on ventilation of battery room.

4. TESTS

Tests must be performed on fully charged batteries according to EN 60896-1. In addition, special test instructions such as EN 50272-2 must be observed.

5. FAULTS

Should faults be detected in the battery or the charging device, customer services should be called in immediately. Measurement records under Section 3 are necessary for fast fault detection and removal.

6. STORAGE AND TAKING OUT OF OPERATION

Should cells/batteries be stored or taken out of operation for a longer period of time, they must be stored fully charged in a dry, frost-free room with max. temperature of 25 °C. Direct sunlight or other heat sources must be avoided. To avoid damage the following charging methods can be chosen:

- 6.1 Equalizing charges** on a quarterly basis as under Section 2.4. In average, ambient temperatures of more than 30 °C monthly equalizing charges may be necessary.
- 6.1 Float charging** as under Section 2.3. above.

7. TRANSPORT

Batteries, wet, filled with acid require transport under demands of European Agreement concerning the international carriage of dangerous goods (ADR and RID). ADR special provision No. 598: New batteries are not subject to the requirements of ADR, when:

- + they are secured in such a way that they can not slip, fall or be damaged;
- + they are provided with carrying devices, unless they are suitably stacked, e.g. on pallets;
- + there are no dangerous traces of alkalis or acids on the outside;
- + they are protected against short circuits.

8. TECHNICAL DATA

The nominal voltage, number of blocks, nominal capacity (C10 = CN) and the battery type are obtained from the type plate.

8.1 Example. Date on type plate:

6V 4 OPzS 200

6V = Nominal voltage of the blocks battery (with individual cells the nominal voltage is 2 V)

4 = Number of positive plates

OPzS = Type

200 = Nominal capacity C10 under EN 60896-1.

Capacity with discharge period of 10 h (t10) to final discharge voltage 1,80 V/cell. Other capacities at different discharge currents with the corresponding discharge times and final discharge voltage can be found in technical data sheet for TAB OPzS stationary batteries.

BATTERIES ARE PRODUCED IN ACORDANCE WITH EN 60896-11.

GAS GENERATION

FOR STATIONARY VENTED LEAD-ACID OPzS BATTERIES

During charge, float charge and overcharge gases are evolved from all lead-acid (LA) secondary cells and batteries. This is a result of the electrolysis of the water by overcharging current. Gases produced are hydrogen (H₂) and oxygen (O₂). When evolved into ambient atmosphere an explosive mixture may be created if the hydrogen (H₂) concentration exceeds 4 % hydrogen in air.

When a cell reaches its fully charged state water electrolysis occurs according to Faraday's law. Under standard condition (NTP):

- + 1 Ah decomposes H₂O into: 420 cm³ H₂ and 210 cm³ O₂
- + decomposition of 1 cm³ (1 g) H₂O requires: 3 Ah
- + 26,8 Ah decomposes H₂O into: 1 g H₂ and 8 g O₂

When charging is stopped the emanation of gas from cells can be regarded as having come to end after one hour.

VENTILATION REQUIREMENTS

From EN 50 272-2: The minimum airflow rate for ventilation of a TAB d.d. stationary battery location or compartment shall be calculated by the following formula: $Q = 0.05 \cdot n \cdot I_{gas} \cdot Crt \cdot 10^{-3} [m^3/h]$

- + n = number of cells
- + I_{gas} = I float or boost [mA/Ah] relevant for calculation (see Table 1)
- + Crt = capacity C₁₀ for lead acid cells (Ah), U_f = 1.80 V/cell at 20 °C..."

The following table states the values for I_{gas} to be used for TAB d.d. batteries:

- + TAB (Sb < 2%): OPzS, OGi,
- + TAB VRLA: OPzV

Table 1: I_{gas} acc. to EN 50 272-2 for IU- and U-charging depending on operation and lead acid battery type (up to 40 °C operating temperature)

OPERATION	VENTED CELLS (Sb < 2 %)	VRLA CELLS
Float charging	2,23 V/cell at 20 °C (0,20 mA/Ah) I_{gas} = 5	2,27 V/cell at 20 °C (0,025 mA/Ah) I_{gas} = 1
Boost charging	2,40 V/cell at 20 °C (0,8 mA/Ah) I_{gas} = 20	2,40 V/cell at 20 °C (0,20 mA/Ah) I_{gas} = 8

The gas producing current I_{gas} can be reduced to 50 % of the values for vented cells in case of use of recombination vent plugs (catalyst). With natural ventilation (air convection) the minimum inlet and outlet area is calculated as follows: $A \geq 28 \times Q [cm^2]$ (Air convection speed ≥ 0.1 m/s)

Example 1:

Given: 220 V battery, 110 cells, C₁₀ = 200 Ah, vented type, Antimony (Sb) < 3 % (LA) in Float service

Calculation of fresh air necessary:
 $Q = 0.05 \cdot n \cdot I_{gas} \cdot Crt \cdot 10^{-3} [m^3/h]$
n = 110
I_{gas} = 5 (see table 1)
Crt = 200
Q = 5,5 m³/h A ≥ 154 cm²

Example 2:

Same battery as in example 1, but VRLA-type.

I_{gas} = 1 to be used (instead of 5).
Q = 1,1 m³/h A ≥ 31 cm².

CAPACITY OF TAB STATIONARY LEAD ACID BATTERIES

as a f (temperature)

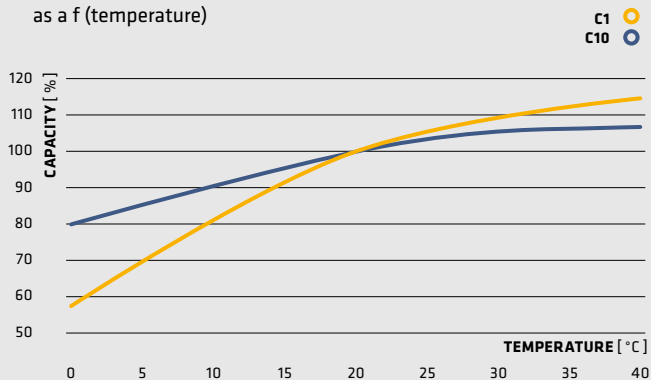

DESIGN LIFE OF TAB OPzS BATTERIES

Dept of discharge (DOD) vs. Number of cycles

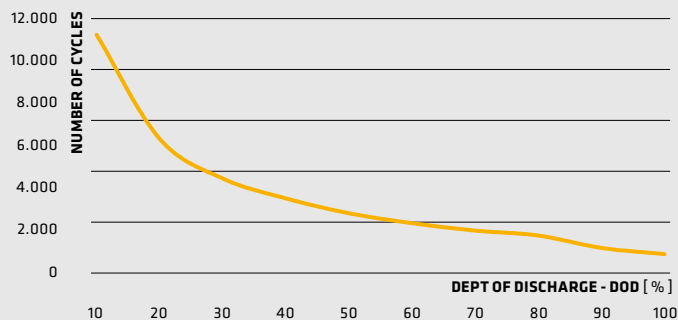

INTERNAL RESISTANCE OF TAB OPzS BATTERIES

as a function of Dept of discharge (DOD)

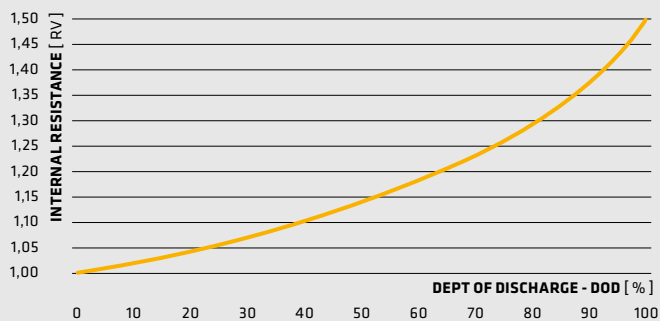

SELF DISCHARGE OF TAB OPzS BATTERIES

as a f (temperature, time)

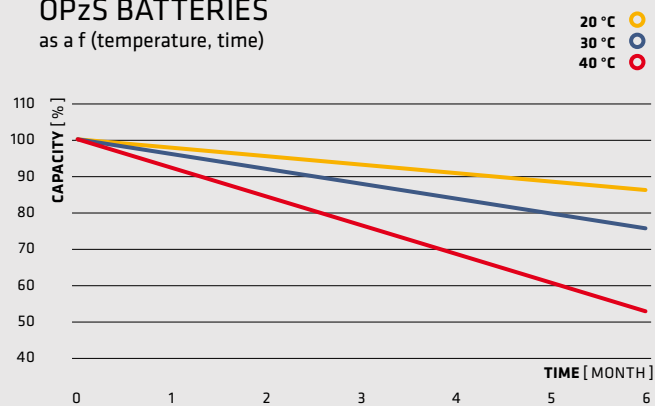

DESIGN LIFE OF TAB OPzS BATTERIES

as a f (temperature, time)

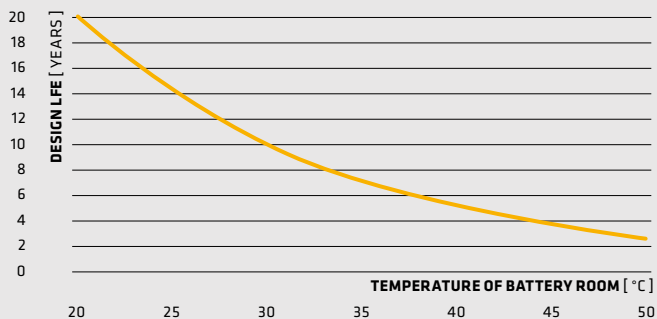

Ignoring the operating instructions, repair with non-original parts will render warranty void.

SPENT BATTERIES MUST BE COLLECTED SEPARATELY AND RECYCLED.

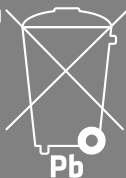

SAFETY REQUIREMENTS ACCORDING TO EN 50272-3.



Pay attention to the operating instructions and keep them close to the battery. Work on batteries should be carried out by skilled personnel only!



No smoking! Do not expose batteries to naked flames, glowing embers or sparks, as it may cause the battery to explode.



Use protective glasses and clothes when working on batteries. Pay attention to the accident prevention rules as well as EN 50272-3 and EN 50110-1.



Risk of explosion and fire, avoid short circuits! Caution: metal parts of the battery are always live. Do not place tools or other metal objects on the battery! Do not remove the plugs.



Electrolyte is strongly corrosive. Risk of corrosion caused by leaking electrolyte.



Batteries and cells are heavy. Ensure secure installation! Use only suitable handling equipment. Lifting hooks must not damage the cells, connectors or cables.



Dangerous voltage! Caution: Metal parts of the battery are always alive - avoid contact and short circuits. Do not place tools or other metal object on the battery!



Acid splashes into the eyes or on the skin must be washed with plenty of water. In case of accident after abundant flushing consult a doctor immediately! Clothing contaminated by acid should be washed in water.

WARRANTY TERMS AND CONDITIONS FOR STATIONARY VENTED LEAD-ACID OPzS BATTERIES

In accordance with the terms and conditions, we offer a 24 month warranty period for the faultless operation of the battery, starting after the date of purchase. The purchase must be proven with the original receipt and a warranty certificate. The receipt and warranty certificate must contain the following information:

- + name and address of the buyer;
- + date of purchase;
- + accurate battery information: type, serial number, nominal voltage and capacity;
- + stamp and signature of retailer.

WE HEREBY UNDERTAKE THAT ALL FAULTS AND TECHNICAL DIFFICULTIES WITH PRODUCTS UNDER WARRANTY WILL BE FIXED FREE OF CHARGE UNDER THE FOLLOWING CONDITIONS:

- + the faulty battery is delivered with a valid warranty certificate and original receipt;
- + the battery has been used and maintained in accordance with the operation manual;
- + the battery is being charged using a suitable charger;
- + the charging currents do not exceed 15 A/100 Ah for OPzV;
- + the battery is without any mechanical damage;
- + the installation procedure and service repairs have been performed by the manufacturer or an authorized person;
- + the manufacturer's repair service was informed immediately after the occurrence of the fault.

WARRANTY IS VALID FOR ANY FAULTS THAT OCCUR DURING THE WARRANTY PERIOD AND FOR DEFECTS THAT CAUSE THE BATTERY TO STOP FUNCTIONING PROPERLY IN ACCORDANCE WITH THE MANUFACTURER'S INFORMATION:

- + the capacity of a fully charged battery is less than 80 % of the nominal capacity (C10) at a nominal temperature of 20 °C;
- + a short-circuit in one or more cells of the battery;
- + an obvious disconnection within the cell.

CONTACT INFORMATION FOR CUSTOMER CLAIMS:

- + please contact your supplier.

WARRANTY DOES NOT APPLY IN THE FOLLOWING CASES:

- + mechanical damage or ordinary wear of the battery;
- + improper installation or maintenance work conducted by unauthorized personnel;
- + improper or careless handling of the battery that is not in accordance with the manufacturer's instructions;
- + failure to perform regular capacity measurements;
- + the introduction of additives into the electrolyte.

WARRANTY DOES NOT APPLY IN CASE OF FAILURE TO COMPLY WITH THE MANUFACTURER'S INSTRUCTIONS.

The warranty includes services like maintenance work and the provision of necessary replacement parts. We guarantee the availability of replacement parts for 3 year after the end of the warranty period. A capacity test performed by a unauthorized person and without our supervision is not binding in terms of this warranty.

THE MANUFACTURER IS NOT LIABLE FOR ANY INDIRECT DAMAGE THAT COULD POTENTIALLY OCCUR DUE TO THE FUNCTION OR MALFUNCTION OF THE BATTERY.

TAB