

TAB STARTER BATTERIES

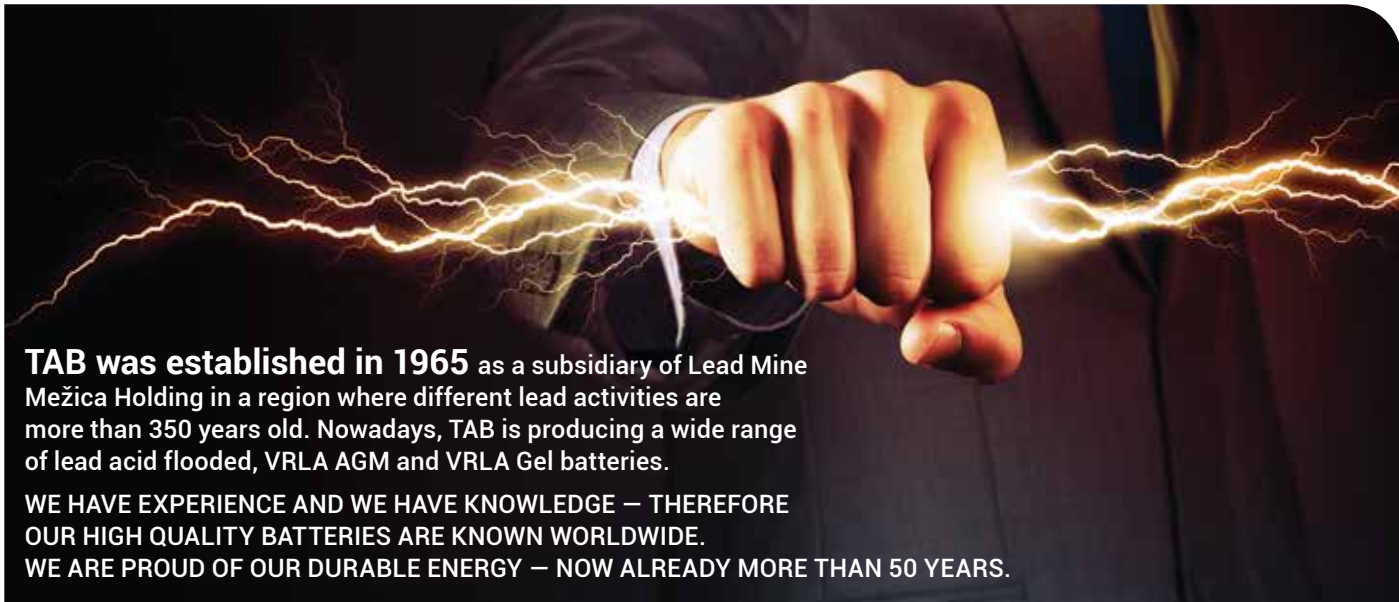

TAB

TAB POLAR
TAB MAGIC
TAB POLAR TRUCK
TAB MAGIC TRUCK
TAB EFB Stop & Go
TAB AGM Stop & Go
TAB OEM



TAB was established in 1965 as a subsidiary of Lead Mine Mežica Holding in a region where different lead activities are more than 350 years old. Nowadays, TAB is producing a wide range of lead acid flooded, VRLA AGM and VRLA Gel batteries.

WE HAVE EXPERIENCE AND WE HAVE KNOWLEDGE – THEREFORE OUR HIGH QUALITY BATTERIES ARE KNOWN WORLDWIDE. WE ARE PROUD OF OUR DURABLE ENERGY – NOW ALREADY MORE THAN 50 YEARS.

TAB Tovarna Akumulatorskih Baterij d. d., Polena 6, SI-2392 Mežica, Slovenia | info@tab.si | +386 (0)2 8702 300 | www.tab.si

ENERGY IN MOTION

EMS TRUCK BATTERIES

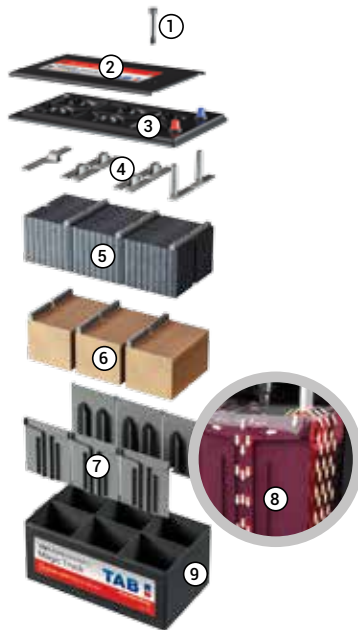

- 1 Electrolyte level indicator – Magic Eye
- 2 Top SMF lid with central degassing and flame arrestors (Battery manufactured by using Sb/Ca technology is fitted with a Flat lid with M27 plugs, for easy access)
- 3 Main SMF lid with labyrinth for additional safety and very low water loss
- 4 Robust plate connectors with large surface inter cell welds, increasing cranking power
- 5 Negative plate with additives for increased charging abilities. Permanent sulfation is severely restricted
- 6 Positive plates with thick casted grids. High-density active mass increases cycle life plus enhanced resistance to deep discharge
- 7 Integrated flexible ribs which generate adequate pressure to the plate stack in all states of charge
- 8 New cell design promotes acid motion in vertical direction, eliminating stratification
- 9 Impact resistant polypropylene container

Allowable shelf life (SELFDISCHARGE)

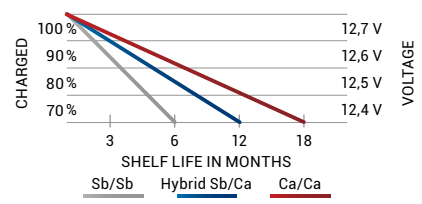

Water consumption (g/Ah)

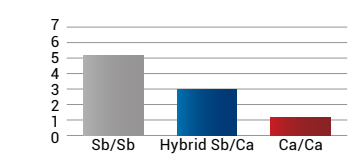

Layout

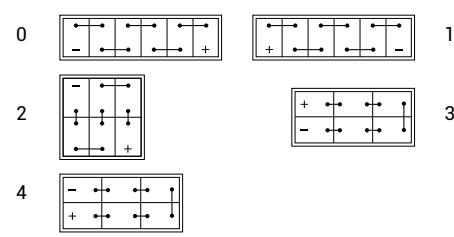

Glossary of remarks

- K** Kamina
- H** Handle
- KH** Kamina Handle
- ME** Magic Eye
- HD** Heavy Duty
- SMF** Maintenance Free = Sealed
- JIS** Japanese Poles
- DP** Dual Poles
- A** Pole Adapter
- AGM** Absorbed Glass Mat
- EMS** Electrolyte Mixing System
- M** Lawn Mower Battery

Base hold down

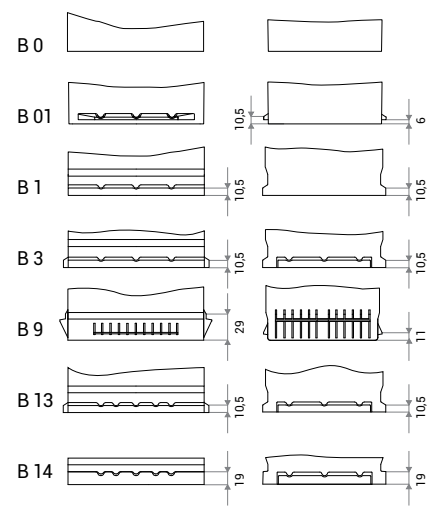

Terminals

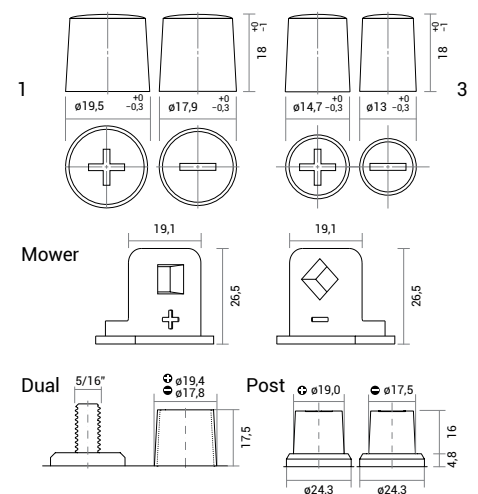

TAB POLAR is battery produced using Ca/Ca expanded metal technology designed for vehicles with entry level of electric equipment with demand of superior starting, performance and reliability. TAB Polar is real all rounder offering excellent power, capacity, cold start performance and reliability. SMF lid/cover provides complete roll over spill protection and is entirely maintenance free throughout the batteries life. This is high quality product for vehicles of every class.

- + High starting capabilities
- + Sealed cover construction
- + Explosion protection prevents flame brake-in into the battery
- + Reliable starting at extreme climatic conditions



TAB POLAR

Flooded starter batteries, Ca/Ca technology

TAB ID	DIN marking	JIS marking (old/new)	Short code	C20 (Ah)	RC (min)	Box type	EN (A)	L×W×H (mm)	BHD	Layout	Weight (kg)	PCS/Pallet (EUR/CNT)	Remarks
217025			U1R-25	25	36	U1	250	196×127×159/185	B0	0	7,2	96/128	SMF, H
217125			U1-25	25	36	U1	250	196×127×159/185	B0	1	7,2	96/128	SMF, H
217032			U1R-32	32	48	U1	350	196×127×159/185	B0	0	8,0	96/128	SMF, H
217132			U1-32	32	48	U1	350	196×127×159/185	B0	1	8,0	96/128	SMF, H
246835	53520 SMF	NS40ZL SMF, 36B20L SMF	S35J	35	53	53520	300	196×128×202/223	B0	0	9,4	96/128	SMF, H, JIS
246935	53522 SMF	NS40Z SMF, 36B20R SMF	S35JX	35	53	53522	300	196×128×202/223	B0	1	9,4	96/128	SMF, H, JIS
246735	53521 SMF	NS40ZL SMF, 36B20L SMF	S35JP	35	53	53520	300	196×134×202/223	B01	0	9,4	96/128	SMF, H, JIS
245445	54506		P45	45	71	L0	400	175×175×190	B13	0	10,5	72/120	K
246036	53649 SMF		P36	36	55	L1B	330	207×175×175	B13	0	10,2	80/120	SMF, H
246044	54002 SMF		S40	40	62	L1B	360	207×175×175	B13	0	10,6	72/120	SMF, H
246144	54003 SMF		S40X	40	62	L1B	360	207×175×175	B13	1	10,6	72/120	SMF, H
246045	54502 SMF		S45	45	71	L1B	420	207×175×175	B13	0	11,3	72/120	SMF, H
246646	54559 SMF		P45H	45	71	L1	400	207×175×190	B13	0	11,7	72/100	SMF, H
246050	55010 SMF		S50H	50	81	L1	450	207×175×190	B13	0	12,2	72/100	SMF, H
246145	54520 SMF	NS60LS BHD	S45J	45	71	53520	400	196×134×202/223	B01	0	10,6	72/96	SMF, H, JIS
246545	54522 SMF	NS60S BHD	S45JX	45	71	53522	400	196×134×202/223	B01	1	10,6	72/96	SMF, H, JIS
246845	54523/84 SMF	NS60LS SMF, 46B24LS SMF	S45JA	45	71	54523/84	400	236×128×202/223	B0	0	11,9	72/96	SMF, H, JIS, A
246945	54524/51 SMF	NS60S SMF, 46B24RS SMF	S45JAX	45	71	54524/51	400	236×128×202/223	B0	1	11,9	72/96	SMF, H, JIS, A
246855	55523/84 SMF		S55JA	55	90	54523/84	540	236×128×202/223	B0	0	13,5	72/96	SMF, H, JIS, A
246755	55524/51 SMF		S55JAX	55	90	54524/51	540	236×128×202/223	B0	1	13,5	72/96	SMF, H, JIS, A
246250	55001 SMF		P50	50	81	L2B	450	242×175×175	B13	0	12,8	63/108	SMF, H
246055	55509 SMF		S55	55	90	L2B	500	242×175×175	B13	0	13,3	63/108	SMF, H
246060	56009 SMF		S60	60	100	L2B	550	242×175×175	B13	0	13,9	63/108	SMF, H
246160	56265 SMF		S60X	60	100	L2B	550	242×175×175	B13	1	13,9	63/108	SMF, H
246455	55559 SMF		P55H	55	90	L2	500	242×175×190	B13	0	14,0	63/90	SMF, H
246062	56008 SMF		S60H	60	100	L2	600	242×175×190	B13	0	14,4	63/90	SMF, H
246861	56068 SMF	N50ZL SMF, 55D23L SMF	S60J	60	100	56068	600	230×173×200/220	B01	0	14,8	60/90	SMF, ME, H
246960	56069 SMF	N50Z SMF, 55D23R SMF	S60JX	60	100	56069	600	230×173×200/220	B01	1	14,8	60/90	SMF, ME, H
246867	56568 SMF		S65J	65	110	56068	650	230×173×200/220	B01	0	15,3	60/90	SMF, ME, H
246965	56569 SMF		S65JX	65	110	56069	650	230×173×200/220	B01	1	15,3	60/90	SMF, ME, H
246263	56309 SMF		P63	63	106	L3B	600	278×175×175	B13	0	15,4	51/80	SMF, H, HD
246073	57309 SMF		S73	73	126	L3B	630	278×175×175	B13	0	15,9	51/80	SMF, H, HD
246866	56638 SMF		P66H	66	112	L3	600	278×175×190	B13	0	16,1	51/80	SMF, H, HD
246074	57412 SMF		S74H	74	128	L3	680	278×175×190	B13	0	17,1	51/80	SMF, H, HD
246374	57413 SMF		S74HX	74	128	L3	680	278×175×190	B13	1	17,1	51/80	SMF, H, HD
246870	57029 SMF	NS70L SMF, 65D26L SMF	S70J	70	120	57029	700	259×175×200/221	B1	0	17,0	48/80	SMF, ME, H
246770	57024 SMF	NS70 SMF, 65D26R SMF	S70JX	70	120	57024	700	259×175×200/221	B1	1	17,0	48/80	SMF, ME, H
246875	57529 SMF		S75J	75	130	57029	740	259×175×200/221	B1	0	17,6	48/80	SMF, ME, H
246775	57524 SMF		S75JX	75	130	57024	740	259×175×200/221	B1	1	17,6	48/80	SMF, ME, H
246292	59249 SMF		P92H	92	165	L4	800	315×175×190	B13	0	19,9	42/60	SMF, H, HD
246889	58803 SMF		P88	88	156	L5B	720	353×175×175	B13	0	19,9	36/72	SMF, H, HD
246092	59220 SMF		S92	92	165	L5B	800	353×175×175	B13	0	20,4	36/72	SMF, H, HD
246192	59221 SMF		S92X	92	165	L5B	800	353×175×175	B13	1	20,4	36/72	SMF, H, HD
246888	58827 SMF		P88H	88	156	L5	720	353×175×190	B13	0	20,7	36/60	SMF, H, HD
246600	60038 SMF		S10H	100	182	L5	850	353×175×190	B13	0	21,7	36/60	SMF, H, HD
246895	59518 SMF	NX120-7L SMF, 105D31L SMF	S95J	95	171	59518	850	306×173×200/221	B01	0	20,5	42/70	SMF, ME, H
246995	59519 SMF	NX120-7 SMF, 105D31R SMF	S95JX	95	171	59519	850	306×173×200/221	B01	1	20,5	42/70	SMF, ME, H
245610	61002		P11H	110	203	L6	1000	394×175×190	B13	0	24,5	36/60	KH, HD
246495	BCI 31 SMF		S95BCI	95	171	BCI 31	700	330×173×218/239	B1	0	24,4	42/60	SMF, ME, H, HD
246410	BCI 31S SMF		S110BCI	110	203	BCI 31	1000	330×173×218/239	B1	0	25,7	42/60	SMF, ME, H, HD
246695	BCI 31 SMF-D		S95BCID	95	171	BCI 31	700	330×173×218/237	B1	0	24,4	42/60	SMF, ME, H, HD, DP
246610	BCI 31S SMF-D		S110BCID	110	203	BCI 31	1000	330×173×218/237	B1	0	25,7	42/60	SMF, ME, H, HD, DP

TAB POLAR TRUCK

Flooded starter batteries, **Sb/Ca** technology | TRUCK batteries | Flat lid with M27 plugs

TAB ID	DIN marking	Short code	C20 (Ah)	RC (min)	Box type	EN (A)	LxWxH (mm)	BHD	Layout	Weight (kg)	PCS/Pallet (EUR/CNT)	Remarks
116105	61028	TR11	110	203	60528	800	345x172x218/238	B0	0	25,3	36/48	H
116405	61028	TR11P	110	203	60528	800	345x175x218/238	B1	0	25,3	36/48	H
484912	61044	TR11M	110	203	MAC110	720	509x175x182/208	B3	3	31,1	24/40	H, HD
125810	62047	TR12	120	225	60528	900	345x172x218/238	B0	0	26,7	36/48	H
116125	62512	TR12H	125	236	62512	800	345x172x269/289	B0	0	31,8	24/36	H
942912	63530	TR13A	135	258	A	850	513x189x194/220	B0	3	35,6	24/35	H, HD
487912	63544	TR13M	135	258	MAC110	850	509x175x182/208	B3	3	33,3	24/40	H, HD
944912	63545	TR13MR	135	258	MAC110	850	509x175x182/208	B3	4	33,3	24/40	H, HD
946912	64323	TR14M	143	276	MAC143	900	509x216x184/210	B3	3	38,7	21/35	H, HD
149913	64518	TR14B	145	280	B	900	512x222x194/221	B0	3	39,7	21/28	H, HD, EMS
488912	65048	TR15M	150	292	MAC110	1000	509x175x182/208	B3	3	36,9	24/40	H, HD
150913	67018	TR17	170	338	B	1050	512x222x194/221	B0	3	42,7	21/28	H, HD, EMS
151913	67019	TR17R	170	338	B	1050	512x222x194/221	B3	4	42,7	21/28	H, HD, EMS
152913	68032	TR18	180	361	B	1100	512x222x194/221	B0	3	43,7	21/28	H, HD, EMS
153913	69032	TR19	190	385	B	1200	512x222x194/221	B0	3	45,4	21/28	H, HD, EMS
154913	70032	TR20B	200	409	B	1200	512x222x194/221	B0	3	45,4	21/28	H, HD, EMS
950912	70027	TR20C	200	409	C	1200	518x273x214/241	B0	3	52,7	18/24	H, HD, EMS
951912	72527	TR22	225	469	C	1300	518x273x214/241	B0	3	56,1	18/24	H, HD, EMS
100712	6TN	TR11D7	110	203	D7	740	282x269x208/230	B0	2	30,8	24/36	H, HD



TAB TRUCK

TAB MAGIC TRUCK

Flooded starter batteries, **Ca/Ca** technology | TRUCK batteries

TAB ID	DIN marking	Short code	C20 (Ah)	RC (min)	Box type	EN (A)	LxWxH (mm)	BHD	Layout	Weight (kg)	PCS/Pallet (EUR/CNT)	Remarks
153612	63544 SMF	TM13M	135	258	MAC110	850	509x175x196/223	B3	3	33,3	24/40	SMF, ME, H, HD
296612	64030 SMF	TM14	140	269	A	850	507x188x200/228	B0	3	35,6	24/35	SMF, ME, H, HD
154612	65048 SMF	TM15M	150	292	MAC110	1000	509x175x196/223	B3	3	36,9	24/40	SMF, ME, H, HD
435612	65018 SMF	TM15	150	292	B	950	513x222x194/221	B0	3	40,4	24/32	SMF, ME, H, HD, EMS
347612	68032 SMF	TM18	180	361	B	1100	513x222x194/221	B0	3	43,5	21/28	SMF, ME, H, HD, EMS
112612	70027 SMF	TM20	200	409	C	1200	517x275x214/241	B0	3	52,7	18/24	SMF, ME, H, HD, EMS
126612	72527 SMF	TM22	225	469	C	1300	517x275x214/241	B0	3	56,1	18/24	SMF, ME, H, HD, EMS

TAB MAGIC utilises the latest innovations in Ca/Ca manufacturing technology, providing for the highest cold start performance and superior reliable power as demanded by the latest generation of cars with high energy drain. The SMF lid/cover provides complete roll over spill protection and is entirely maintenance free throughout the batteries life.

- + Sealed cover construction
- + Higher number of plates ensure 30% better starting capabilities
- + The expanded metal technology results in better corrosion resistance and providing a longer life time
- + The level indicator (magic eye) provides an instant status check
- + Explosion protection prevents flame brake-in into the battery
- + Ideal for cars with lots of electrical equipment
- + Battery of highest quality



TAB MAGIC

Flooded starter batteries, **Ca/Ca** technology | CAR batteries

TAB ID	DIN marking	Short code	C20 (Ah)	RC (min)	Box type	EN (A)	L×W×H (mm)	BHD	Layout	Weight (kg)	PCS/Pallet (EUR/CNT)	Remarks
189054	55401 SMF	M54	54	88	L1B	510	207×175×175	B13	0	12,3	72/120	SMF, ME, H
189058	55510 SMF	M55H	55	90	L1	560	207×175×190	B13	0	12,8	72/100	SMF, ME, H
189063	56249 SMF	M62	62	104	L2B	600	242×175×175	B13	0	14,5	63/108	SMF, ME, H
189065	56649 SMF	M66H	66	112	L2	640	242×175×190	B13	0	15,0	63/90	SMF, ME, H
189072	57510 SMF	M75	75	130	L3B	720	278×175×175	B13	0	16,5	51/80	SMF, ME, H, HD
189080	57549 SMF	M75H	78	136	L3	750	278×175×190	B13	0	17,5	51/80	SMF, ME, H, HD
189085	58514 SMF	M85	85	150	L4B	800	315×175×175	B13	0	18,8	42/72	SMF, ME, H, HD
189099	60032 SMF	M100	100	182	L5B	850	353×175×175	B13	0	21,1	36/72	SMF, ME, H, HD
189800	60044 SMF	M100H	100	182	L5	900	353×175×190	B13	0	22,3	36/60	SMF, ME, H, HD

ENERGY IN MOTION

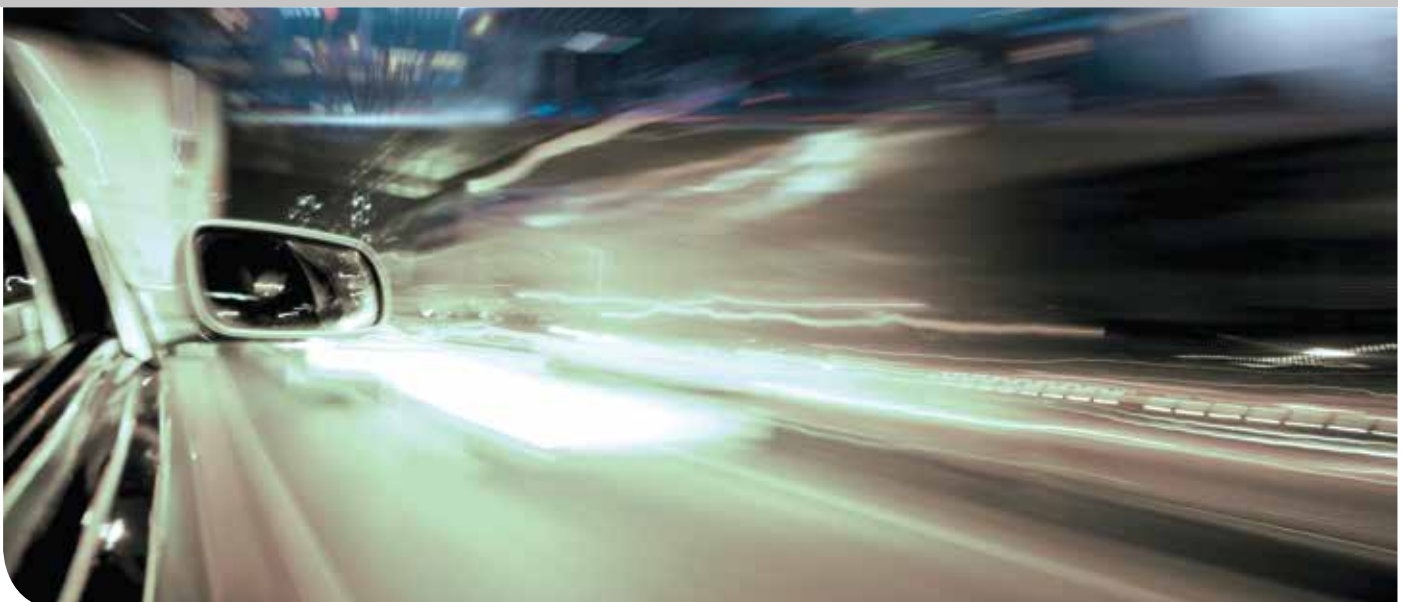

TAB EFB Stop & Go batteries are so called Enhanced Flooded Batteries intended for use in vehicles with entry level Start-Stop function. EFB batteries utilize the latest innovations in Ca/Ca flooded battery manufacturing technology, providing for the superior reliable power as demanded by the latest generation of cars with entry level Start-Stop system.

- + MFV fleece on positive plates, preventing active material shedding boast twice as much cyclic capability as standard batteries and can be more discharged without any loss of functionality
- + Improved charge acceptance for recovering energy more quickly during driving phase using special expander with carbon
- + The expanded metal technology results in better corrosion resistance providing a longer life time
- + Sealed cover construction, roll over proof
- + Maintenance free
- + The level indicator (magic eye) provides an instant status check
- + Explosion protection with flame arrestor

TAB EFB Stop & Go

EFB starter batteries, Ca/Ca technology | CAR batteries

TAB ID	DIN marking	JIS marking (old/new)	Short code	C20 (Ah)	RC (min)	Box type	EN (A)	L×W×H (mm)	BHD	Layout	Weight (kg)	PCS/Pallet (EUR/CNT)	Remarks
212860	56068 SMF	N50ZL SMF, 55D23L SMF	SG60J	60	100	56068	600	230×173×200/220	B01	0	16,4	60/90	SMF, ME, H
212760	56069 SMF	N50Z SMF, 55D23R SMF	SG60JX	60	100	56069	600	230×173×200/220	B01	1	16,4	60/90	SMF, ME, H
212060	56088 SMF		SG60	60	100	L2	580	242×175×190	B13	0	16,4	63/90	SMF, ME, H
212065	56588 SMF		SG65	65	110	L3B	650	278×175×175	B13	0	15,9	51/80	SMF, ME, H, HD
212070	57088 SMF		SG70	70	120	L3	680	278×175×190	B13	0	19,0	51/80	SMF, ME, H, HD
212080	58088 SMF		SG80	80	140	L4	760	315×175×190	B13	0	21,1	42/60	SMF, ME, H, HD
212090	59088 SMF		SG90	90	161	L5	850	353×175×190	B13	0	23,7	36/60	SMF, ME, H, HD
212005	60518 SMF		SG10J	105	192	59518	900	306×173×200/221	B01	0	22,8	42/70	SMF, ME, H
212105	60519 SMF		SG10JX	105	192	59519	900	306×173×200/221	B01	1	22,8	42/70	SMF, ME, H
455612	74027 SMF		SG24	240	506	C	1250	517×275×214/241	B0	3	59,6	18/24	SMF, ME, H, HD, EMS

Our contribution to low CO₂ emissions



TAB AGM Stop & Go batteries are Valve Regulated Lead Acid batteries intended for use in vehicles with enhanced level Start-Stop function with break energy recuperation. VRLA AGM battery is improved lead acid battery to its maximum performance. The battery cells are closed by a pressure relief valve and electrolyte is immobilized in absorbed glass mat (AGM). Plate stacks are kept in the cells under pressure.

THE ADVANCED CONSTRUCTION OF BATTERY LEADS TO IMPROVED PERFORMANCE IN:

- + Very low water consumption due to internal oxygen recombination
- + Preventing active material shedding boast more than three times as much cyclic capability as standard batteries and can be more discharged without any loss of functionality
- + Increased cranking power due to better utilization of cell volume by more than 30 %
- + High rate charge acceptance for recovering energy more quickly during driving phase
- + Both side pasting of plates provides better corrosion resistance providing a longer life time
- + No acid stratification like in flooded cells
- + Explosive safe - minimum explosive gasses are produced
- + Vibration resistance and no acid leakage in case of crash

TAB AGM Stop & Go

AGM starter batteries, Ca/Ca technology | CAR batteries

TAB ID	DIN marking	Short code	C20 (Ah)	RC (min)	Box type	EN (A)	L×W×H (mm)	BHD	Layout	Weight (kg)	PCS/Pallet (EUR/CNT)	Remarks
213060	L2 AGM	AG60	60	109	L2	680	242×175×190	B13	0	17,9	63/90	AGM, H
213070	L3 AGM	AG70	70	130	L3	760	278×175×190	B13	0	20,5	48/80	AGM, H
213080	L4 AGM	AG80	80	151	L4	800	315×175×190	B13	0	23,2	42/60	AGM, H
213090	L5 AGM	AG95	95	184	L5	850	353×175×190	B13	0	26,0	36/60	AGM, H
213105	L6 AGM	AG105	105	206	L6	950	394×175×190	B13	0	29,2	36/60	AGM, H



**TAB OEM
BATTERIES**



TAB OEM BATTERIES

Flooded starter batteries, Ca/Ca technology | CAR batteries

TAB ID	DIN marking	Short code	C20 (Ah)	RC (min)	Box type	EN (A)	L×W×H (mm)	BHD	Layout	Weight (kg)	PCS/Pallet (EUR/CNT)	Remarks
299070	57012	OEM70A	70	120	L3	640	278×175×190	B13	0	18,7	51/80	KH, HD, AGCO
299075	57512	OEM75T	75	130	L3	640	278×175×190	B13	0	17,9	51/80	KH, HD, THERMO KING
299275	57512 SMF	OEM75P	75	130	L3	800	278×175×190	B13	0	18,5	51/80	SMF, H, HD, PSA
299092	59249	OEM92T	92	165	L4	760	315×175×190	B13	0	21,1	42/60	KH, HD, THERMO KING
299005	61038	OEM105A	105	192	L5	880	353×175×190	B13	0	24,2	36/60	KH, HD, AGCO

